

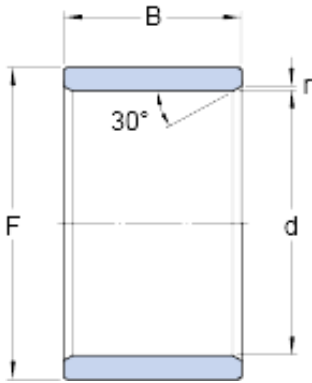

TON BEARING CO.,LTD.



skf LR 17x20x16.5 Needle roller bearing
components inner rings

Bearing No. LR 17x20x16.5

d	17 mm
F	20 mm
B	16.5 mm
r, r _{1,2} min.	0.3 mm
Mass inner ring	0.011 kg

LR 17x20x16.5 Bearing 2D drawings and 3D CAD
models